

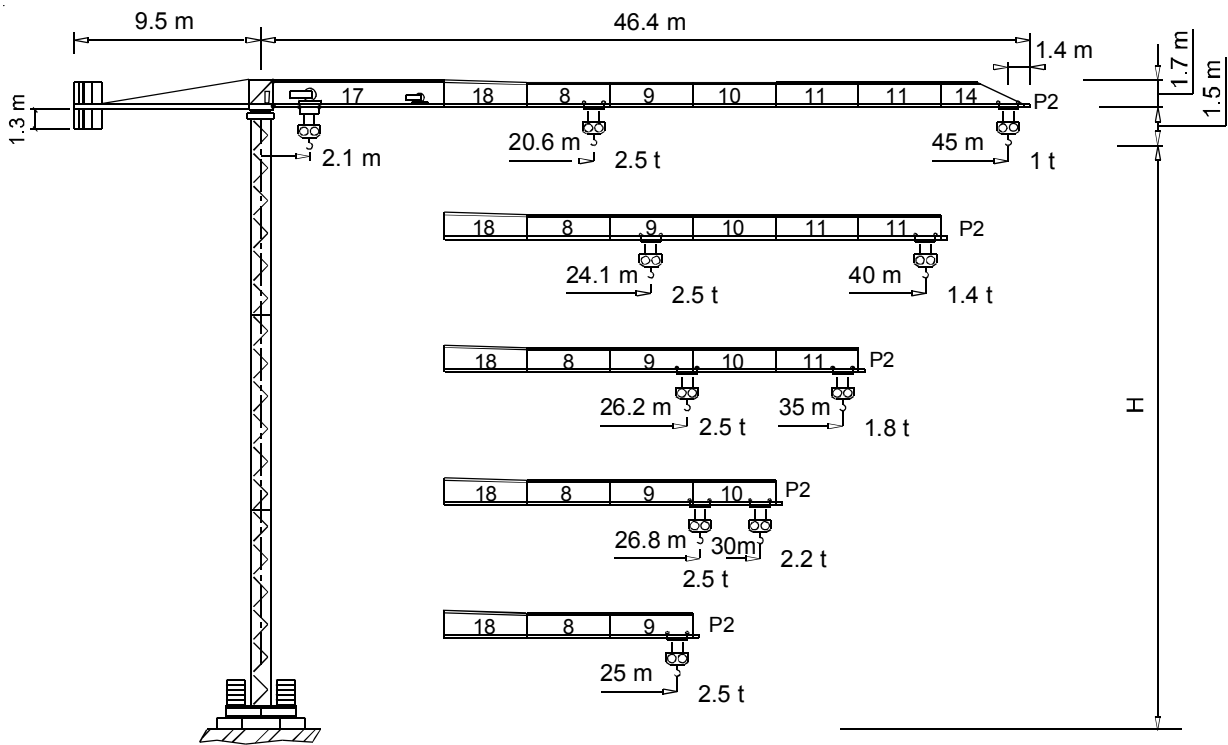

Gru a torre "Flat Top"

"Flat Top" Tower Crane • Grue à tour "Flat Top"

"Flat Top" Turmdrehkran • Grúa torre "Flat Top"



THE **ULTIMATE** CRANE™

Dati illustrativi non impegnativi
Con riserva di modifica senza preavviso

Specifications and data not binding
Subject to modification without notice

Données techniques seulement indicatives
Modifications réservées sans préavis



Angaben und Beschreibung unverbindlich
Änderungen vorbehalten ohne weitere Mitteilung

Dibujos y datos sin compromiso
Modificaciones reservadas sin preaviso

UTE.DOC.REL004

"CITY" CTT 61-2.5 TS12

Diagramma di portata  Courbes de charges  Curvas de cargas 
 Load Diagram  Lastkurven 

CTT 61-2.5											
		m	5	10	15	20	25	30	35	40	45
		t	2.5	2.5	2.5	2.5	2.01	1.63	1.36	1.16	1
2.5 t	- 20.6 m	t	2.5	2.5	2.5	2.5	2.4	1.96	1.64	1.4	
2.5 t	- 24.14 m	t	2.5	2.5	2.5	2.5	2.5	2.15	1.8		
2.5 t	- 26.19 m	t	2.5	2.5	2.5	2.5	2.5	2.2			
2.5 t	- 26.77 m	t	2.5	2.5	2.5	2.5	2.5				
2.5 t	- 25 m	t	2.5	2.5	2.5	2.5	2.5				

Altre installazioni  Autres implantations  Otras implantaciones 
 Other configurations  Aufstellmöglichkeiten 

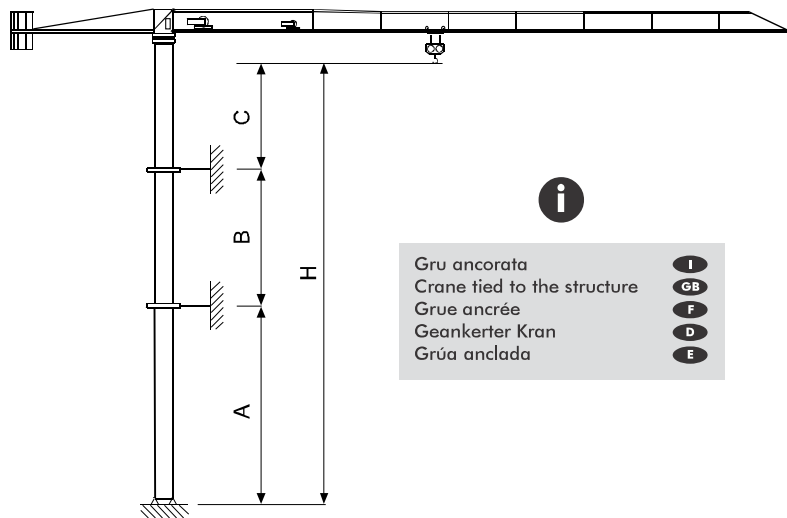

Torre	●	Tour	⦿	Torre	⦿
Tower	⊗	Turm	⦿		

TS12

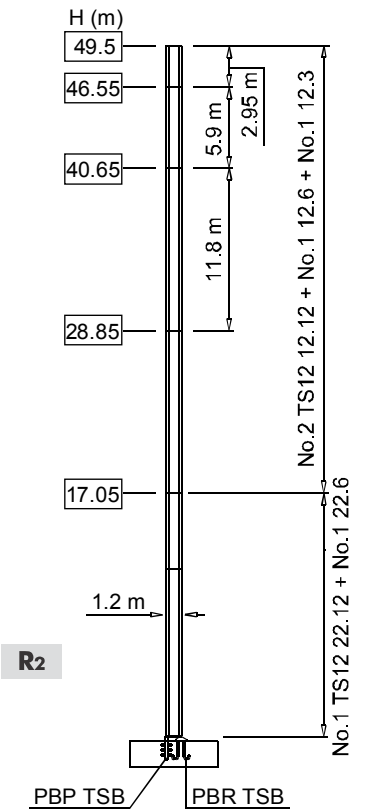
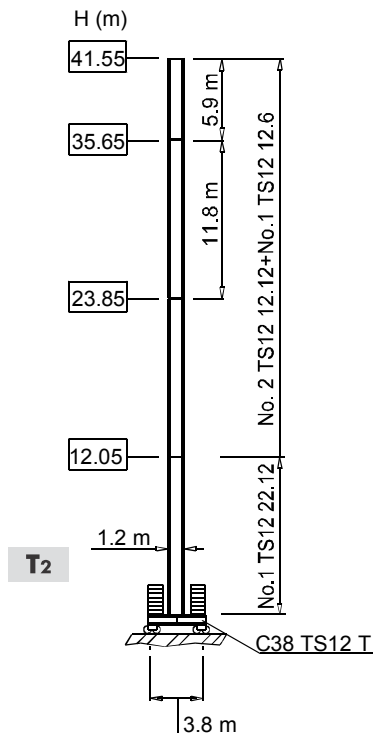
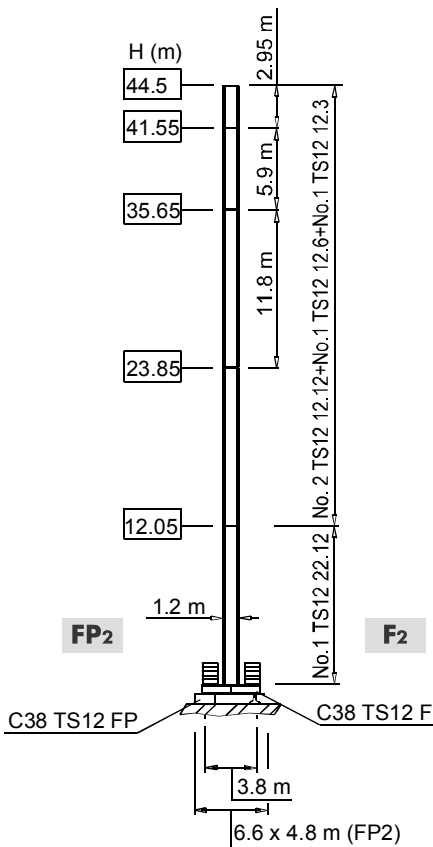
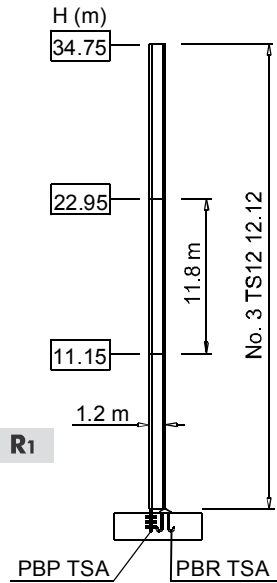
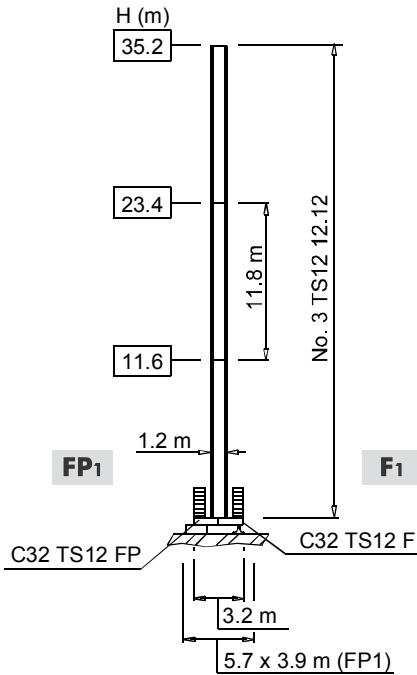

- Le prolunghe TS sono disponibili in lunghezze 11.8 m, 5.9 m, 2.95 m.
- ⊗ The available lengths for the TS tower sections are 11.8 m, 5.9 m, 2.95 m.
- ⦿ Les éléments de mât TS sont disponibles en longueur 11.8 m, 5.9 m, 2.95 m.
- ⦿ Die Turmschüsse TS sind mit Längen 11.8 m, 5.9 m, 2.95 m verfügbar.
- ⦿ Los tramos de torre TS son disponibles en las medidas de largo 11.8 m, 5.9 m, 2.95 m.

Meccanismi
Mechanisms



Mécanismes
Antriebe





Mecanismos



















































				
11 APC 25	29 * kVA	400 V - 50 Hz		2000/14/CE
15 AFC 25	38 * kVA	400 V - 50 Hz / 460 V - 60 Hz		

* Gru senza traslazione / Crane without travelling equipment / Grue sans translation / Krane ohne Schienenfahren / Grúa sin traslación

		m/min	ii	kW	
11 APC 25		6	2.5	11	186 m
		20	2.5		
		40	1.25		
15 AFC 25 (VARIANT)		0 \Rightarrow 1.7	2.5	15	186 m
		1.7 \Rightarrow 6	2.5		
		6 \Rightarrow 28	2.5		
		28 \Rightarrow 46	1.44		
		46 \Rightarrow 57	1.1		

		400 v - 50 Hz	
	DAD 2 2 D1	0 - 22 - 44 m/min	2.2-1.5 kW
	DVF 3 4 D4 (VARIANT)	0 \Rightarrow 6 \Rightarrow 30 \Rightarrow 60 m/min	4 kW
	SSR 1 1 50	0 \Rightarrow 0.87 r.p.m.	1 \times 50 Nm
	TAD 1RP 2M3	0 - 24 m/min	2 \times 3 kW
			

	Sollevarmento		Hoisting		Levage		Heben		Elevación	
	Traslazione carrello		Trolleying		Distribution		Katzfahren		Distribución	
	Rotazione		Slewing		Orientation		Schwenken		Orientación	
	Traslazione		Travelling		Translation		Schienenfahren		Traslación	
	Direttiva sul livello acustico		Directive on noise level		Directive sur le niveau acoustique		Richtlinie für den Schall-Leistungspegel		Directiva sobre el nivel acustico	
	Consultateci		Consult us		Nous consulter		Auf Anfrage		Consultarnos	
	Potenza totale richiesta		Power requirements		Puisissance totale nécessaire		Geforderte Stromstärke		Potencia necesaria	
	Alimentazione		Power supply		Alimentation		Stromversorgung		Alimentación	

Sídlo společnosti

Závod 01 - Otrokovice

Jeřábový a výtahový servis, s.r.o.
Napajedelská 1779
76502 Otrokovice
tel.: +420 602 116 728
Fax.: +420 577 922 212
e-mail: petr.vacek@jvsieraby.cz

Závod 02 - Praha

Jeřábový a výtahový servis, s.r.o.
Kutnohorská 425
109 00 Praha – Měcholupy
tel.: +420 603 470 380
e-mail: tomas.vacek@jvsieraby.cz

Závod 03 - Bratislava

JVS Slovensko, s.r.o.
Sasinkova 6
811 08 Bratislava
tel. +421 911 116 728
e-mail: slovensko@jvszeriavy.sk

IČO: 46344616
DIČ: CZ46344616
vedená u KOS v Brně
spis. zn. C 5461
www.jvsieraby.cz
Bankovní spojení:
ČSOB: 1455621/0300